

**LACHAPPELL**AUDIO

# **LACHAPPELL AUDIO 583S MKII USER GUIDE**

Version 1.1  
August 2017

# SAFETY INSTRUCTIONS

*TO REDUCE THE RISK OF ELECTRIC SHOCK, DO NOT REMOVE COVER. NO USER SERVICEABLE PARTS INSIDE. CONTACT DIGITAL AUDIO LABS FOR SERVICING.*

The lightning flash with arrowhead symbol, within an equilateral triangle, is intended to alert the user to the presence of uninsulated and/or potentially dangerous voltage within the products enclosure that may be of sufficient magnitude to constitute a risk of electric shock to persons.



The exclamation point within an equilateral triangle is intended to alert the user to the presence of important operating and maintenance (servicing) instructions in the literature accompanying the appliance.



## IMPORTANT SAFETY INSTRUCTIONS

1. Read and understand this entire manual.
2. Keep this manual available for reference.
3. Heed all warnings and precautions in this manual and notices marked on the product.
4. Do not use this product near water or damp environments.
5. Refer all servicing to qualified service personnel. There are no user serviceable components inside the product.
6. The product shall not be exposed to moisture. Do not touch the unit with wet hands. Do not handle the unit or power cord when your hands are wet or damp.
7. The product should be connected to a power supply only of the type described in the operating instructions or as marked on the product.

## CARE

- From time to time you should wipe off the front and side panels and the cabinet with a dry soft cloth. Do not use rough material, thinners, alcohol or other chemical solvents or cloths since this may damage the finish or remove the panel lettering.
- The manufacturer cannot be held responsible for damages caused to persons, personal possessions, or data due to an improper or missing ground connection.

# DIGITAL AUDIO LABS LIMITED WARRANTY

Digital Audio Labs warrants their products against defects in material and workmanship for a period of two years from date of purchase. During this period, Digital Audio Labs will, at its option, repair the defective unit or replace it with a new or rebuilt one.

The warranty does NOT cover:

- Damage due to abuse, misuse, or accident.
- Damage due to operation contrary to the instructions in the product instruction manual.
- Units on which the product serial number has been removed or altered.
- Units that have been serviced by unauthorized personnel.

All implied warranties, including warranties on merchantability and fitness, are limited in time to the length of this warranty. Some states do not allow time limitations on implied warranties, so this limitation may not apply to you. Digital Audio Labs' liability is limited to the repair or replacement of its product. Digital Audio Labs shall in no way be held liable for incidental or consequential damages resulting from the use of their product or its software, including, without limitation, damages from loss of business profits, business interruption, loss of business information or other pecuniary loss. Some states do not allow the exclusion or limitation of incidental or consequential damages, so the above limitation or exclusion may not apply to you.

## REPAIR POLICY

Please do not return the product without obtaining an RMA number first. Contact Digital Audio Labs at [support@digitalaudio.com](mailto:support@digitalaudio.com) to acquire an RMA number. Do not return the product to the place of purchase. Please write the RMA number on the outside of the shipping carton. Any product sent to us without a valid RMA number will be refused. Include the following with the product: a brief description of the problem, your name, return shipping address, phone number and the RMA number. Do not include any accessories. DAL is not responsible for any damage to or loss of the product during transit. We recommend that customers obtain a receipt and tracking number for all packages shipped to us. Turnaround time on repairs is generally ten business days. If you live outside of the United States, please contact your local distributor for warranty service.

Please return product to:  
Digital Audio Labs  
Attn: RMA Number  
1266 Park Road  
Chanhassen, MN 55317  
USA

## WARRANTY SERVICE

You will be required to pay the shipping charges when you ship your product to DAL. DAL will pay for return shipping via UPS ground. We reserve the right to inspect any product that may be the subject of any warranty claim before repair is carried out. For warranty service, we may require proof of the original date of purchase if you have not registered your product with DAL. Final determination of warranty coverage lies solely with Digital Audio Labs.

## NON-WARRANTY SERVICE

If it is determined that the product does not meet the terms of our warranty, you will be billed for labor, materials, return freight and insurance. There is a \$80 USD minimum charge for materials and labor. Appropriate shipping charges will be applied. We require payment in advance of repair by credit card; we accept Visa and Master Card. In the event the charges are over the minimum charge, DAL will contact you and inform you of the cost of the repair before any work is completed.

# CONTENTS

SAFETY INSTRUCTIONS .....	ii
IMPORTANT SAFETY INSTRUCTIONS .....	ii
CARE .....	ii
DIGITAL AUDIO LABS LIMITED WARRANTY .....	1
REPAIR POLICY .....	1
WARRANTY SERVICE .....	1
NON-WARRANTY SERVICE .....	1
MODEL 583S MKII .....	3
BEFORE YOU GET STARTED .....	3
SAFETY PRECAUTIONS .....	4
583S MKII CONTROLS .....	5
CONTROL DETAILS .....	5
GETTING STARTED .....	7
LACHAPPELL AUDIO 583S MKII SPECIFICATIONS .....	8
LACHAPPELL AUDIO SUPPORT .....	9
MODEL 583S MKII DIAGRAM .....	9

## MODEL 583S MKII

The LaChapell Audio 583E series module features a single-ended vacuum tube preamplifier designed for use in the "500 series" format. The microphone input configuration consists of an input transformer with a turns ratio of 1:10 and one ECC83/12AX7 vacuum tube. The instrument input stage bypasses the transformer and goes straight to the tube. The output stage utilizes premium Burr-Brown and THAT Corporation line drivers along with an 80% nickel alloy core transformer to generate a balanced line-level output signal.

## BEFORE YOU GET STARTED

Stated below are a few areas that you must take the time to read before you install and use your 500 Series. You as the owner/user are responsible for completely understanding how to operate this device safely and properly.

- **UNPACKING:** Inspect thoroughly. Although we take extreme care at final assembly and packing, things can happen during transit. It is very important that you contact LaChapell Audio if there is anything broken or damaged upon receipt of package. Included in every package should be: (1) preliminary operating manual, (1) packet of mounting screws, (1) registration card. It is a good idea for you to retain the packaging (box & foam case) in case there is a need to return the unit for service or repair at a later date.
- **SERVICE/REPAIR - WARNING:** With the exception of tube replacement (see below) the user should NOT attempt to service this unit in any way, due to the risk of electrical shock and the presence of lethal voltages inside the 583 while powered. Only Digital Audio Labs personnel are to perform maintenance and service activities. The user should also take note that excessive 'swapping' of tubes will introduce undue wear on the tube socket. It is therefore recommended that tube replacement be performed only when necessary and by technically competent individuals.

Tube replacement: Turn power supply off and remove 583 from the chassis, wait five minutes to allow the vacuum tube to cool before attempting to remove it. Using your fingers, apply a slight circular/rotating motion as you pull it away from the socket. It is important to replace the tube with the same type. When a replacement tube is installed double check that you've inserted the correct tubes into the 583's tube socket BEFORE powering up.

*WARNING: Warranty may be rendered void if tubes other than those listed above have been used at any time.*

## **SAFETY PRECAUTIONS**

- Always provide adequate ventilation by allowing the top vents of your 500 series power supply chassis to remain unobscured. Due to the vacuum tube and the internal secondary power supply, the 583 will get warm, blocking or defeating any existing vent is not recommended.
- Never position the power supply directly above other heat generating sources such as a power amplifier.
- Always provide a source to ground (earth.) Never under any conditions should a power cord that has the 3rd prong for ground missing or defeated be used with the power supply.
- Do not place the 583 in an area where there is a potential for fluids to fall, spill into or come in contact with the 583. If you notice fluids or moisture present inside the 583 DO NOT turn power on! Contact Digital Audio Labs for direction.
- The 583 should only be used with power supply frames that have a >130ma rating per bay.

# 583S MKII CONTROLS

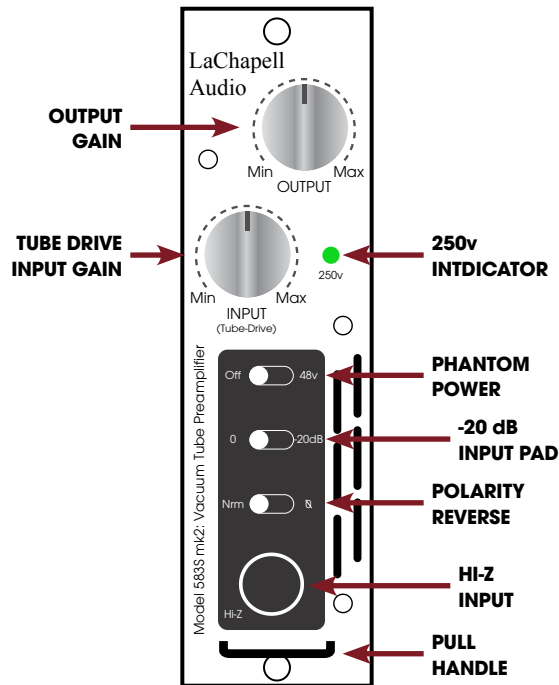

## CONTROL DETAILS

- **TUBE DRIVE / INPUT GAIN:** The INPUT controls how much of the source signal is fed to the first stage of the vacuum tube. Higher levels will drive the tube harder and result in more harmonics. Think of this control as your amount of tube coloration/harmonics (distortion).
- **OUTPUT GAIN:** Provides variable control over line level signal strength. Think of this control as your source for clean gain. Typically, this control is used to establish the desired line level after the input gain has been set but it can work interactively with the INPUT for a wide array of tonal possibilities.
- **HI-Z INPUT:** The HI-Z input stage is transformerless and operates with an input impedance of 100Kohm. It cannot make use of the -20dB pad.
- **48V (Phantom):** This toggle provides a 48 volt supply of DC current for all condenser microphones.
- **20dB INPUT PAD (-20):** When engaged, the microphone input source signal is reduced by 20dB.

### CREATIVE TIP:

For near transformer-less sound, consider engaging this pad function and compensate for the loss of gain by increasing the input gain control. This approach effectively minimizes the gain coming from the Jensen input transformer while drastically increasing the character of the vacuum tube (this is only possible with the microphone path).

- POLARITY REVERSE: Reverses the polarity of the output line level signal.
- 250V INDICATOR: This LED will illuminate green when the internal 250 volt DC/DC converter has the required input/program voltage to function properly.
- PULL HANDLE: This should be used for installation or removal of the device. It also assists in protecting toggle switches.



## GETTING STARTED

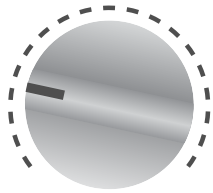

INPUT  
TUBE DRIVE

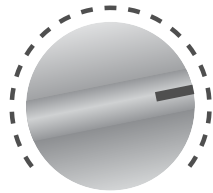

OUTPUT

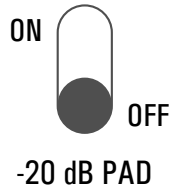

-20 dB PAD

### CLEAN GAIN, HIGH HEADROOM

With the Dual Drive knobs set at INPUT around 25%, OUTPUT around 75%, and the PAD off, you will get a very clean and pristine sound. The distortion is very low with no added harmonics and there is a ton of headroom. This is a great starting position for those wanting a clean tube sound regardless of the microphone type.

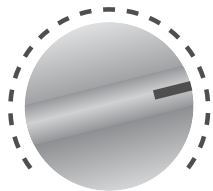

INPUT  
TUBE DRIVE

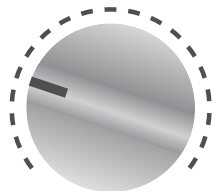

OUTPUT

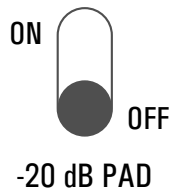

-20 dB PAD

### TUBE HARMONICS AND COMPRESSION

With the Dual Drive knobs set at INPUT around 75%, OUTPUT around 25%, and the PAD off, you will get incredible tube harmonics and that natural tube compression. This would be a great starting position for those wanting to hear what the 583's harmonics are all about. It's also a great place to start when using ribbon or dynamic mics that need a little 583 harmonic color.

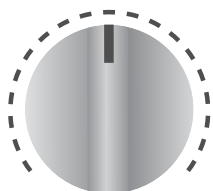

INPUT  
TUBE DRIVE

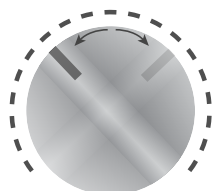

OUTPUT

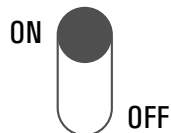

-20 dB PAD

### HEADROOM AND WARMTH

The 583 provides great sonic versatility. With the -20 dB PAD engaged and the INPUT set to around 50% you will hear a rich roundness and warmth. With these settings, the mid-range will move forward and the input headroom is increased as well.

# LACHAPPELL AUDIO 583S MKII SPECIFICATIONS

Internal Gain (microphone)	72dB
Internal Gain (Hi-Z)	52dB
Max output gain	+26dBu (1% THD+N)
Frequency Response	10Hz - 50kHz (-3dB)
THD+N	Variable: 0.050% - 10%
Noise (EIN)	-121dB (150ohm load)
S/N Ratio @ 30dB gain	87dB
Input Impedance (microphone)	1500 Ohm
Input Impedance (Hi-Z)	100K Ohm
Output Impedance	<50 Ohm
Tube Complement/Type	1/ea 12AX7
Power Requirements	120ma

NOTE: Stated specifications are typical measurements but subject to change without notice due to individual traits unique to each tube. All measurements taken while driving a 40kohm load and using a 1khz tone.

# LACHAPPELL AUDIO SUPPORT

Phone Support: 952-401-7700  
Toll Free: 844-DAL-INFO  
Email Support: [support@digitalaudio.com](mailto:support@digitalaudio.com)  
Website: [www.digitalaudio.com/support](http://www.digitalaudio.com/support)

DIGITAL AUDIO LABS  
1266 Park Rd  
Chanhassen, MN 55317

## MODEL 583S MKII DIAGRAM

